

Blank template for your own design.



Side view. Draw design, cut it out and trace on the wood. Flip the block around and repeat on the opposite side. This is necessary as you will need to make sure you are making even cuts on both sides if you are using a coping saw to cut out the design.



Top or bottom view. Use this view if making any cuts out of the sides of the car. As in the above step, trace the outline on the top and bottom so that your cuts are even if using a coping saw.



Front view.



Back view.

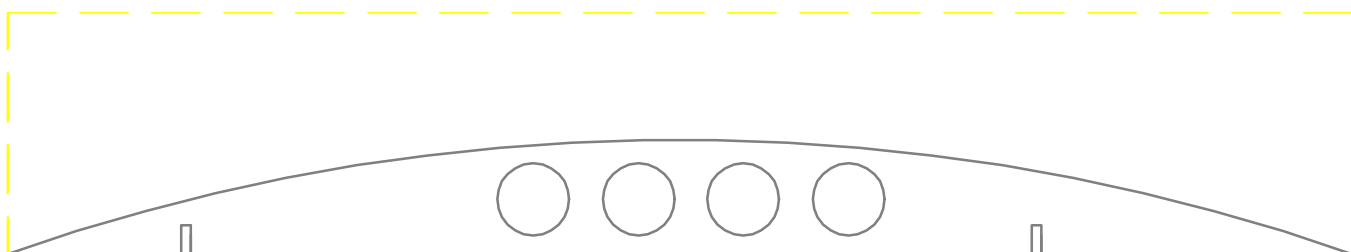
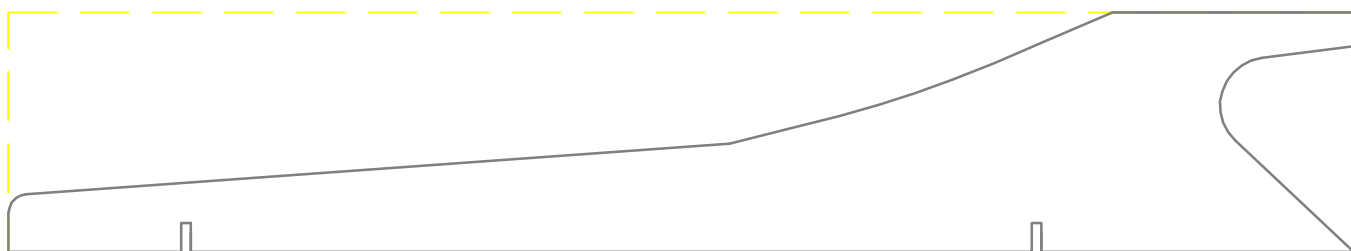

3/8" HOLES FOR WEIGHT

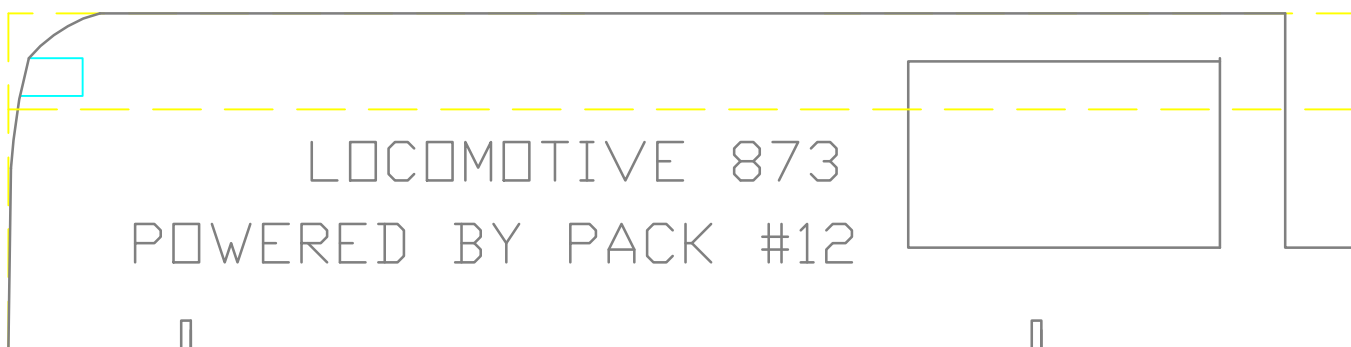

LOCOMOTIVE 873
POWERED BY PACK #12

GLUE EXTRA WOOD TO BLOCK FOR REQUIRED HEIGHT

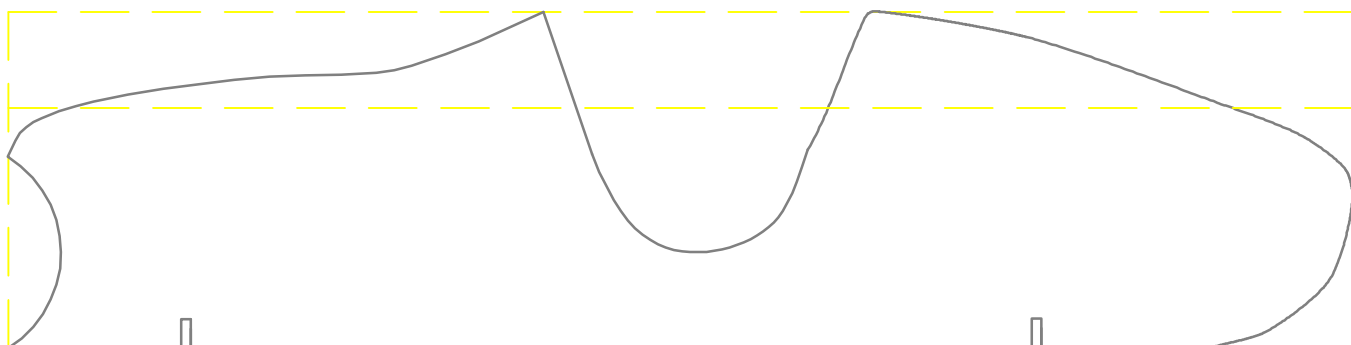

GLUE EXTRA WOOD TO BLOCK FOR REQUIRED HEIGHT

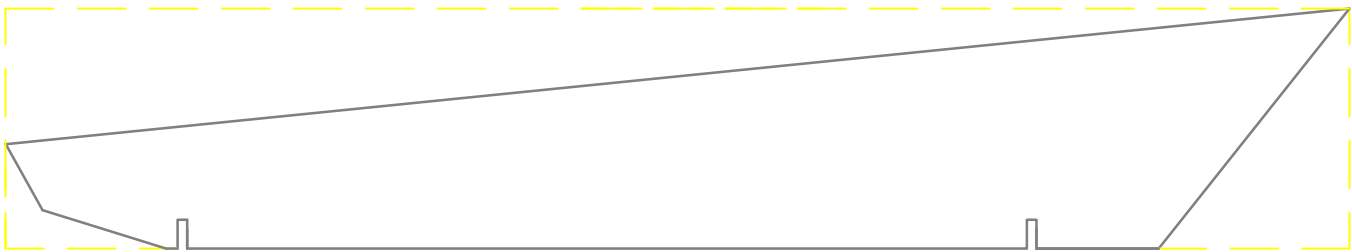
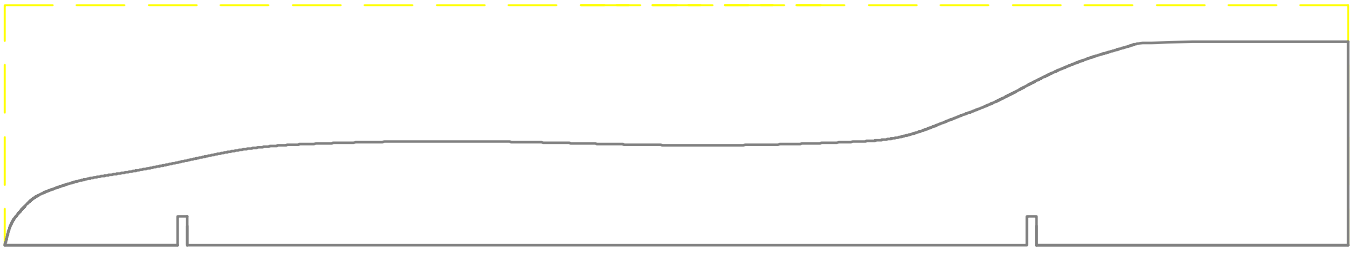

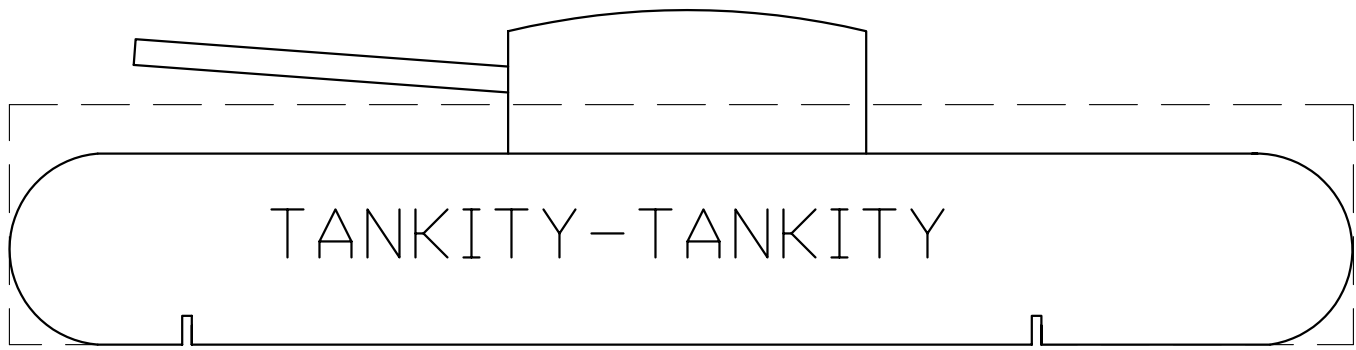

TANKITY-TANKITY

ADD WOOD FOR TURRET AND BARREL



ADD WEIGHT IN 3/8" HOLES

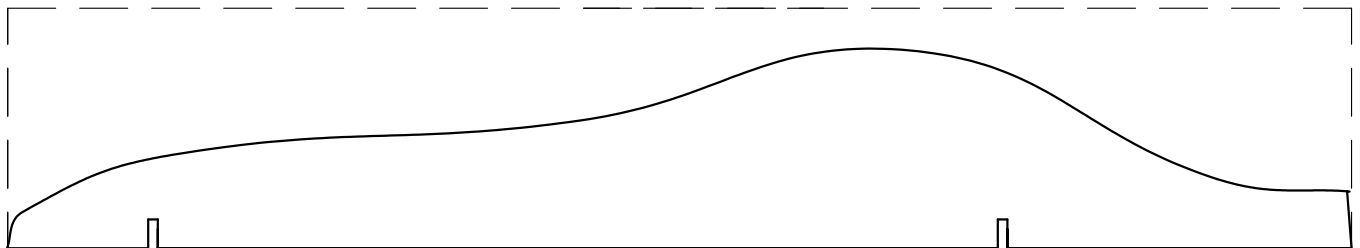
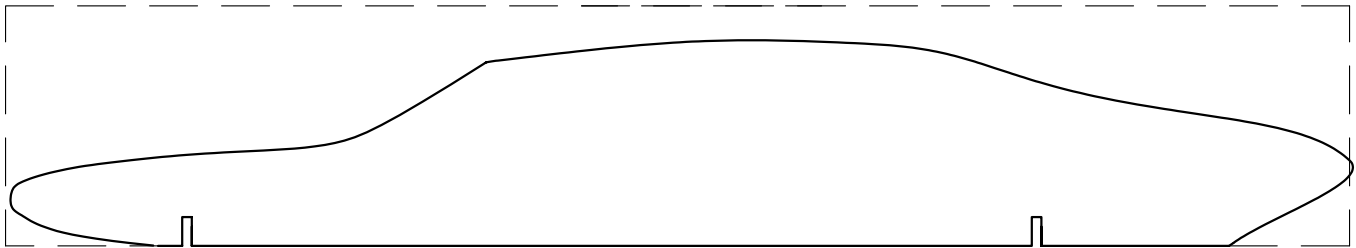

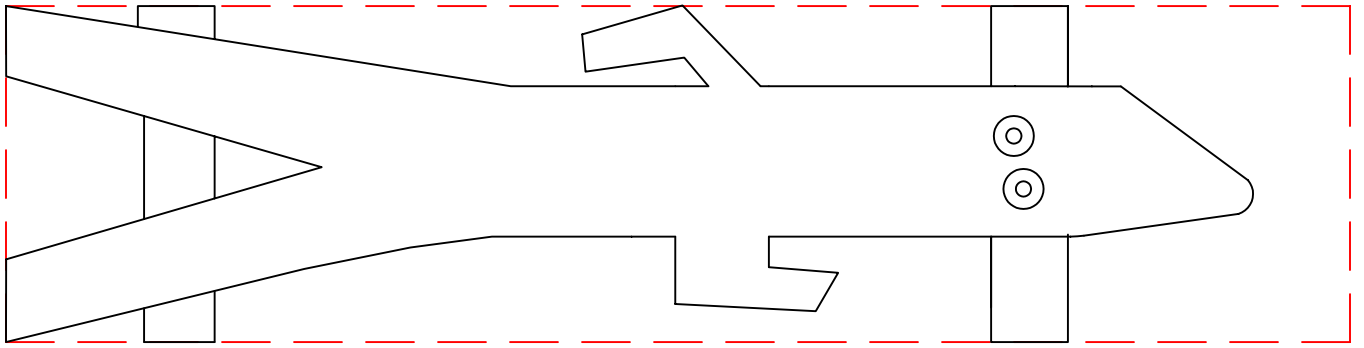

GUMBY

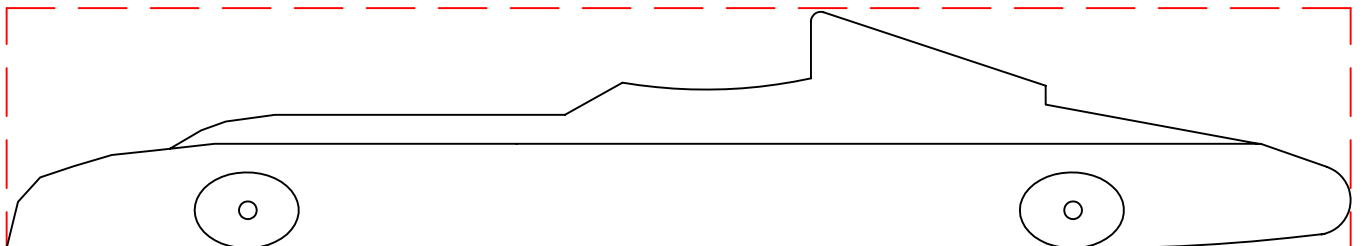
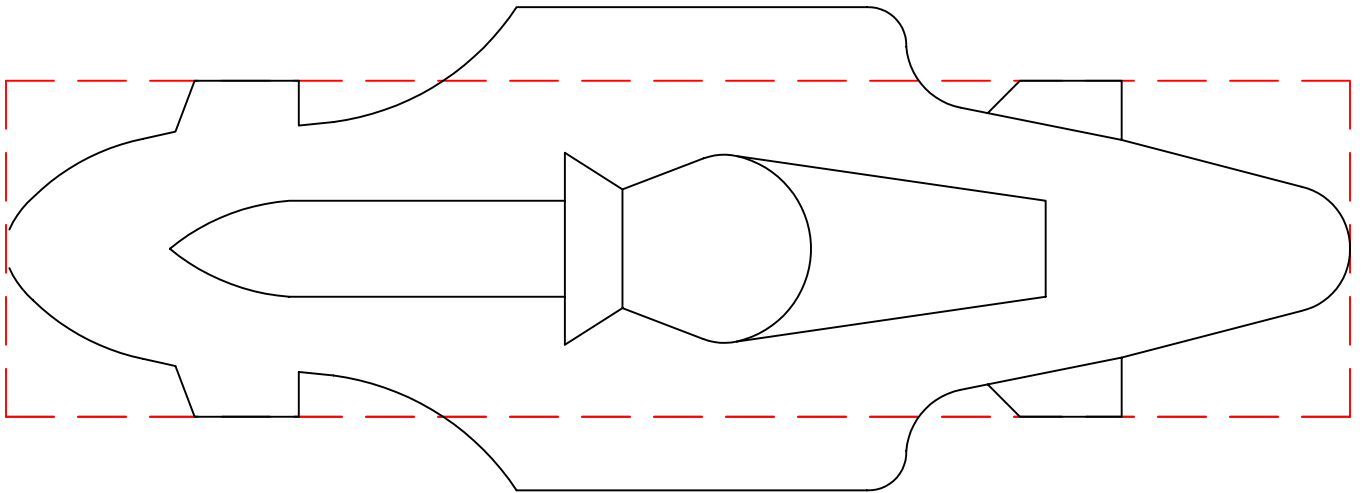
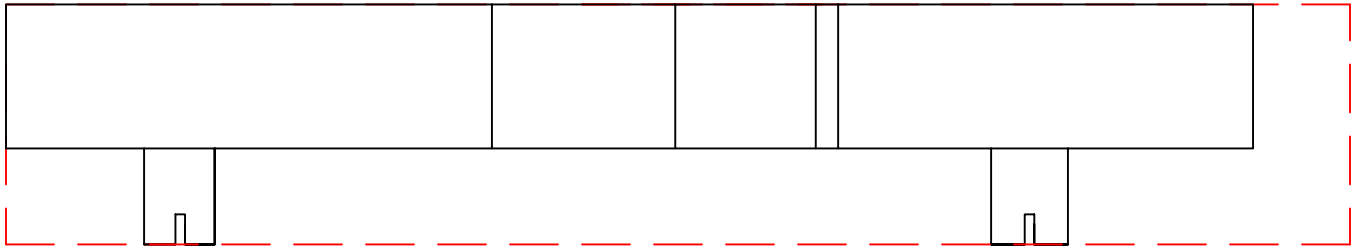

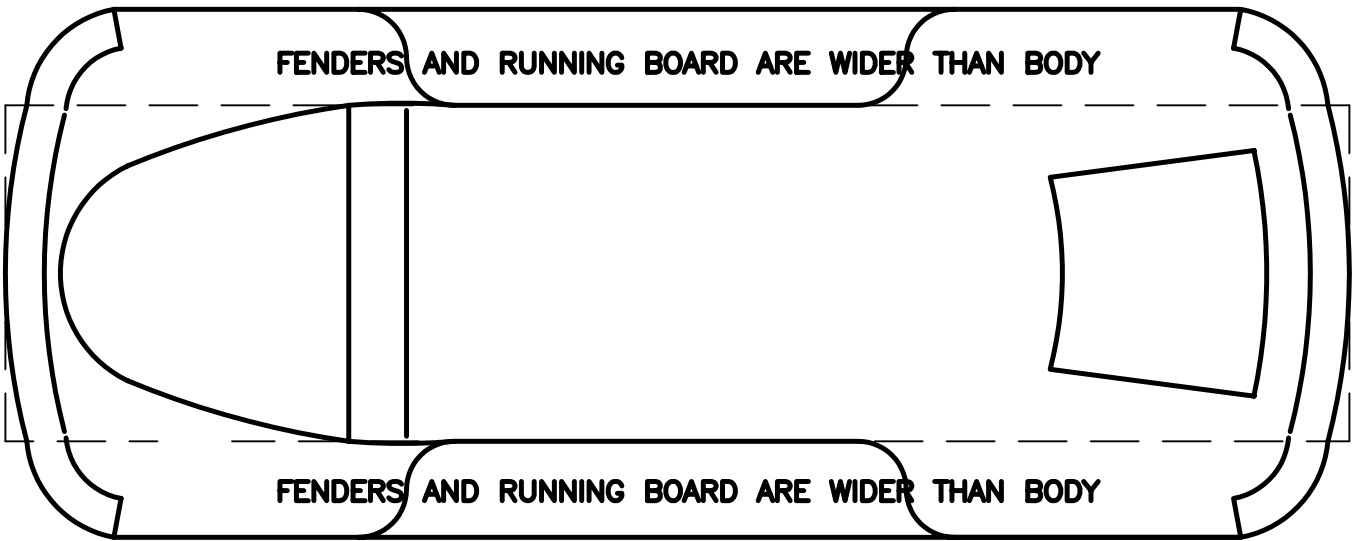

"BUG TOP VIEW"

ADD EXTRA WOOD FOR HEIGHT AND WIDTH

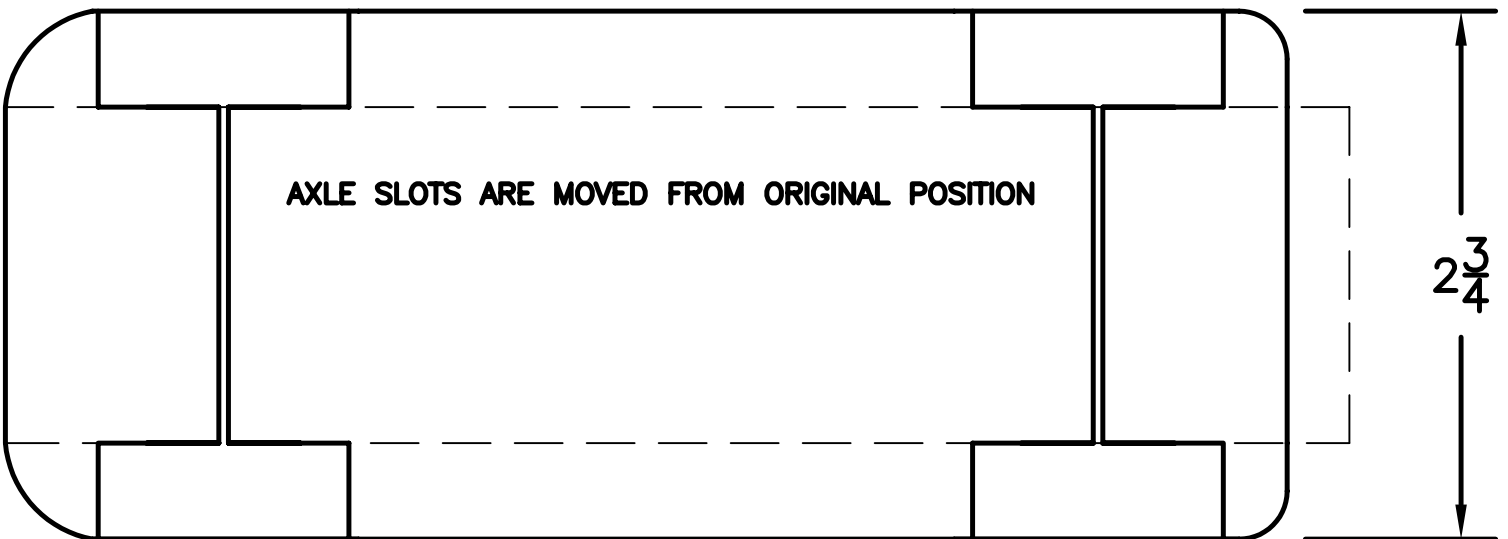
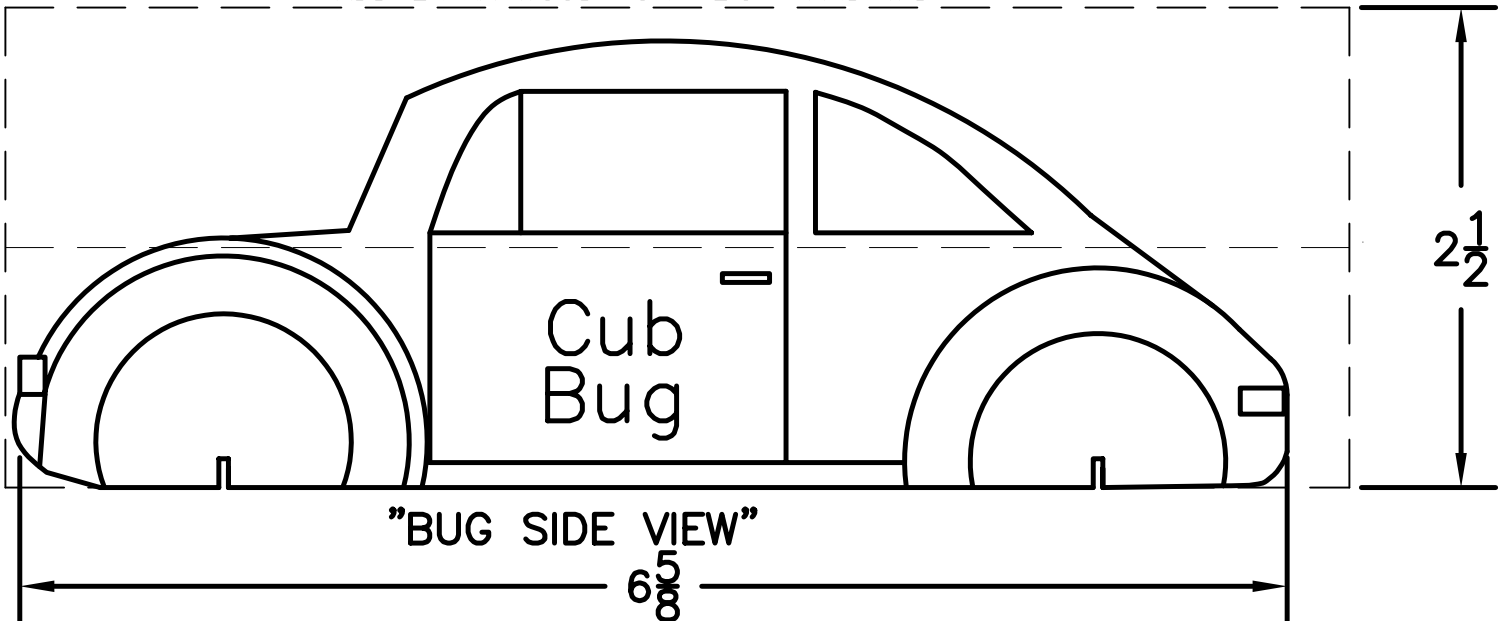

"BUG BOTTOM VIEW"

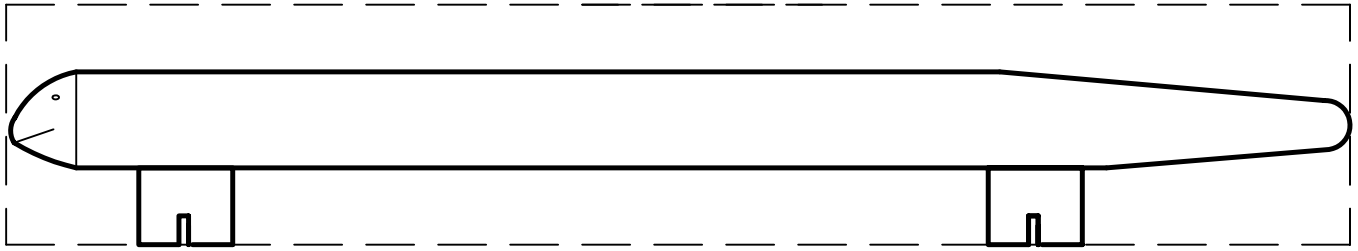

"SNEAKY SNAKE SIDE VIEW"

FRAGILE DESIGN, USE REINFORCEMENT

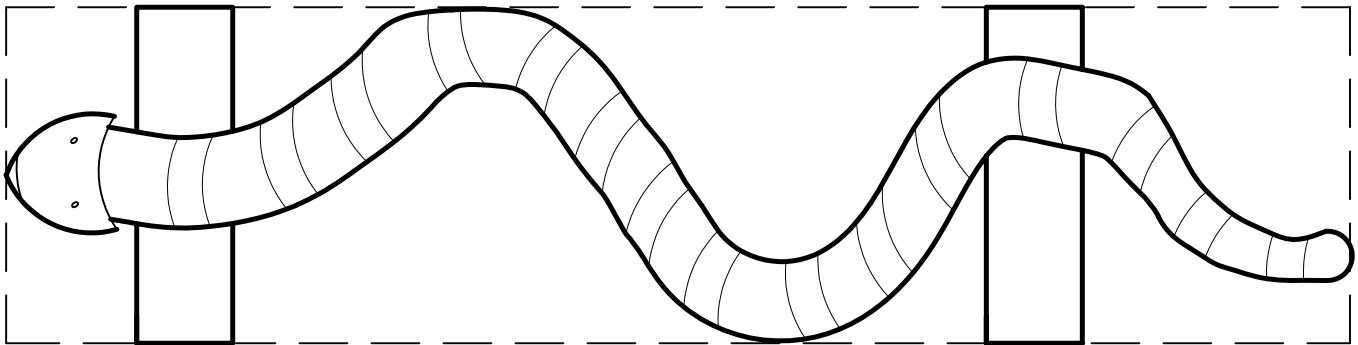

"SNEAKY SNAKE TOP VIEW"

1/8" WOOD DOWELS

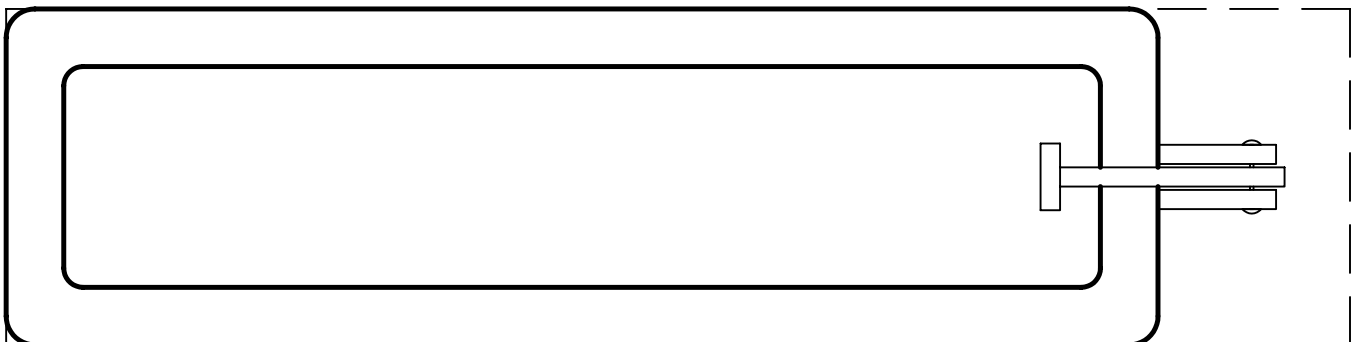

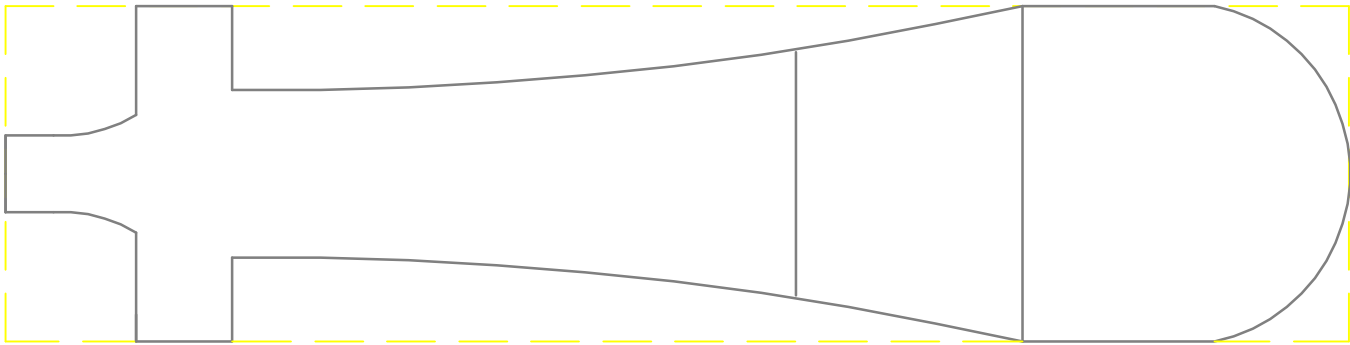
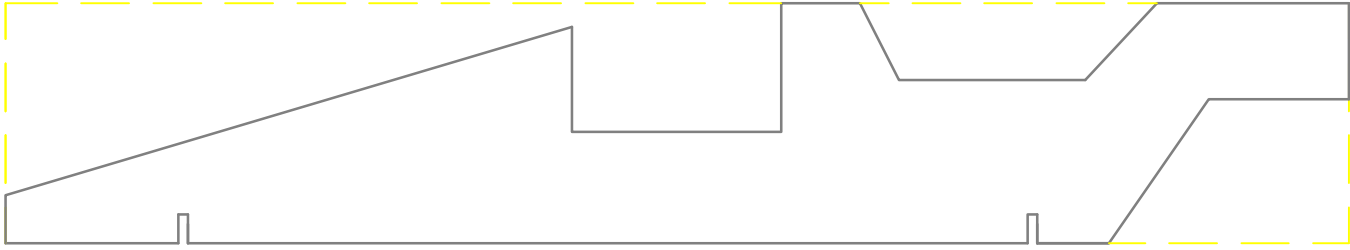

"DRAGSTER TOP VIEW"

"DRAGSTER"

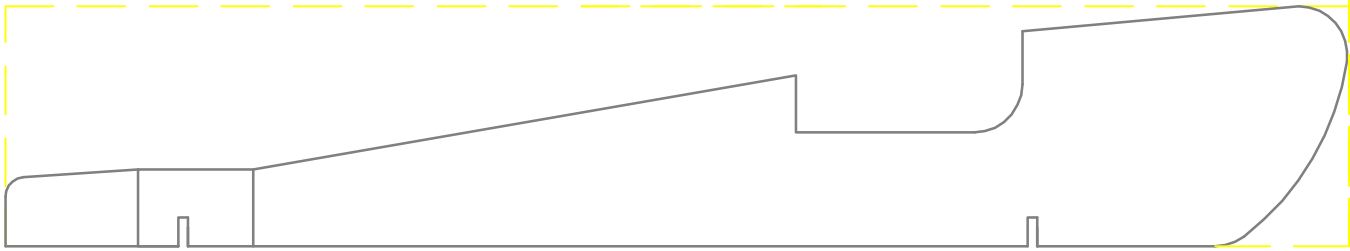

"SLOW SHORT STUFF"



ADD WEIGHT IN 3/8" HOLES

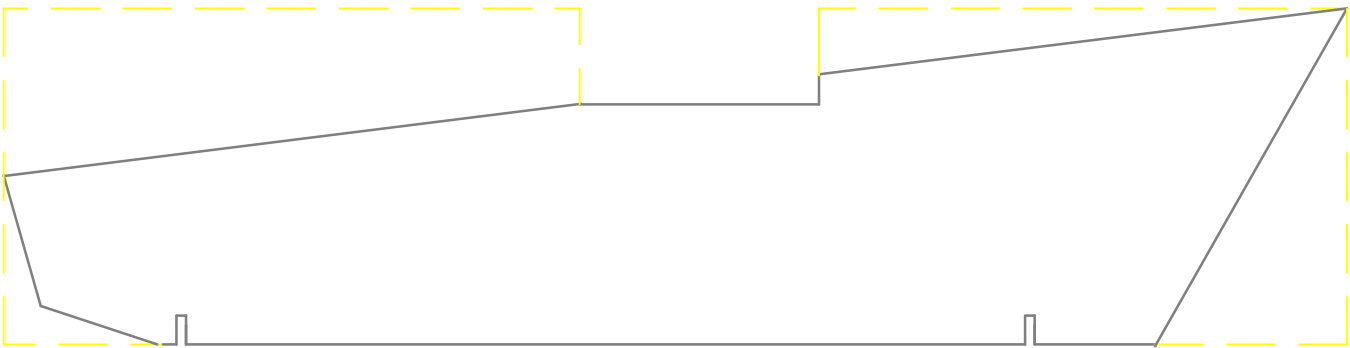
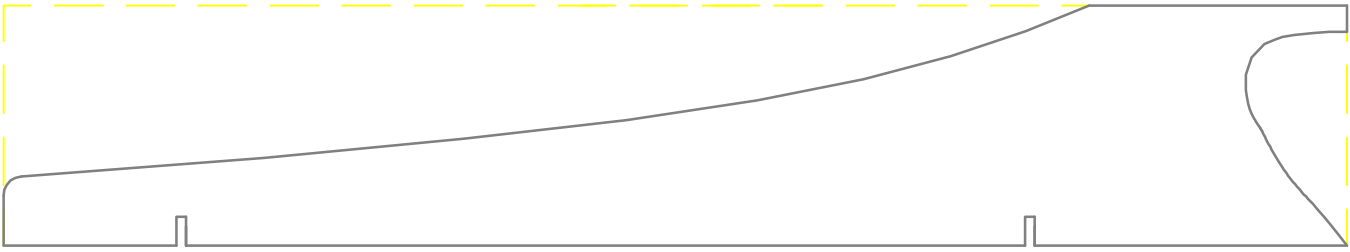
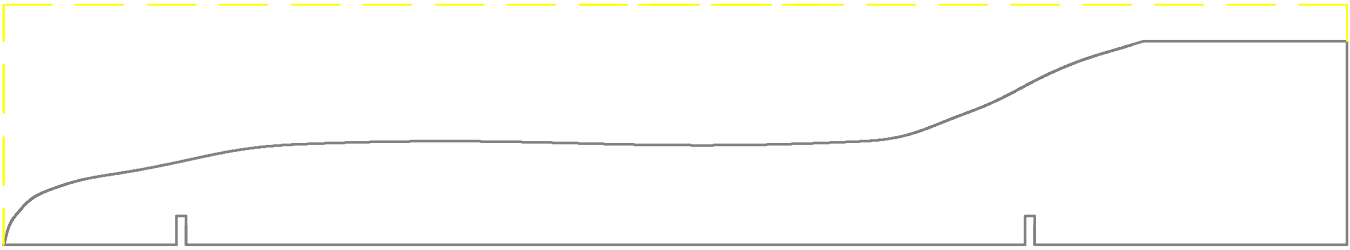

OLD STYLE BLOCK

MINIMOUSE – CUT PROFILE THEN SHAPE BODY

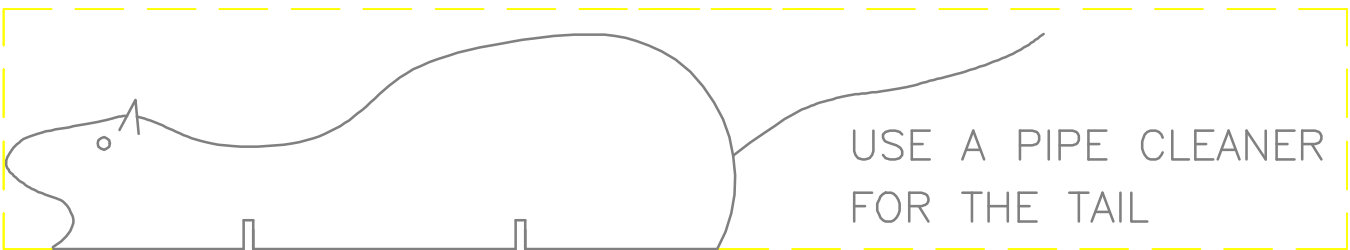

USE A PIPE CLEANER
FOR THE TAIL

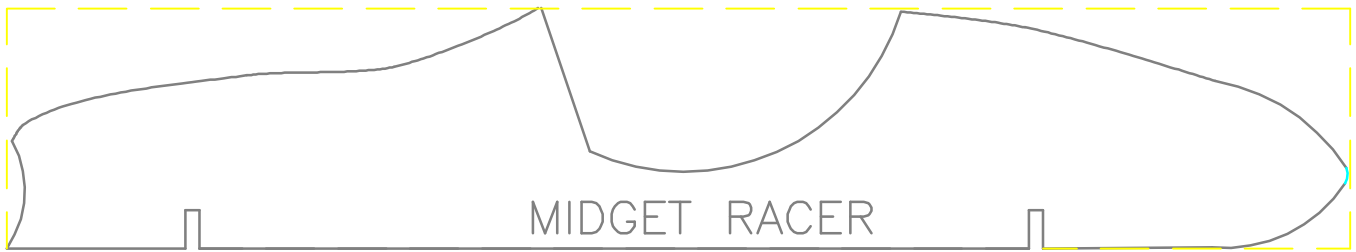
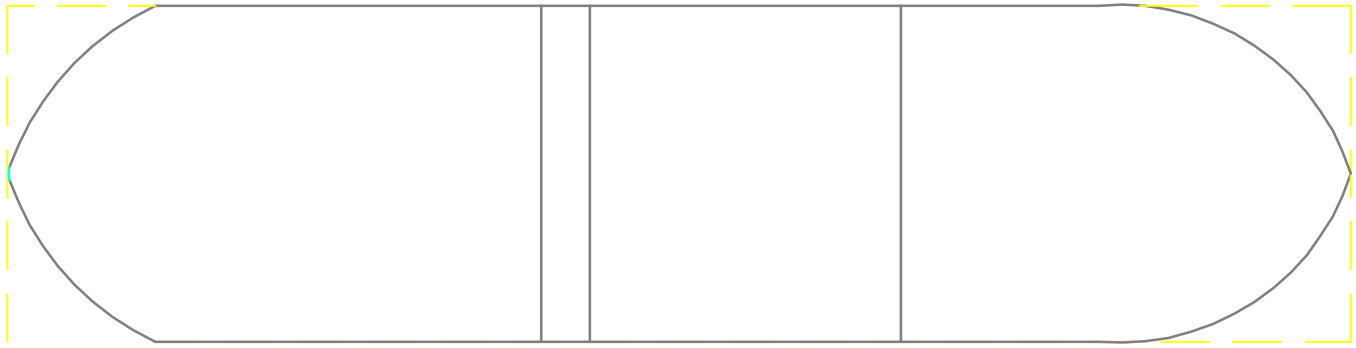

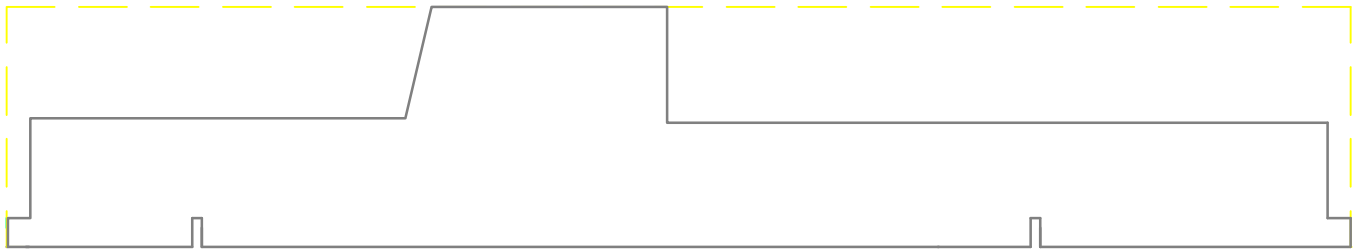
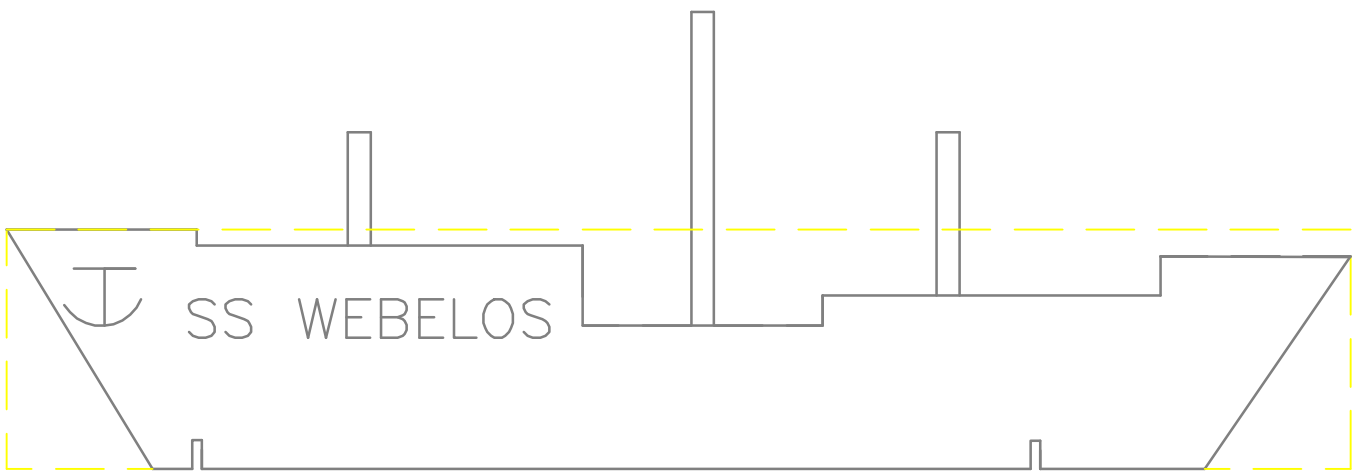
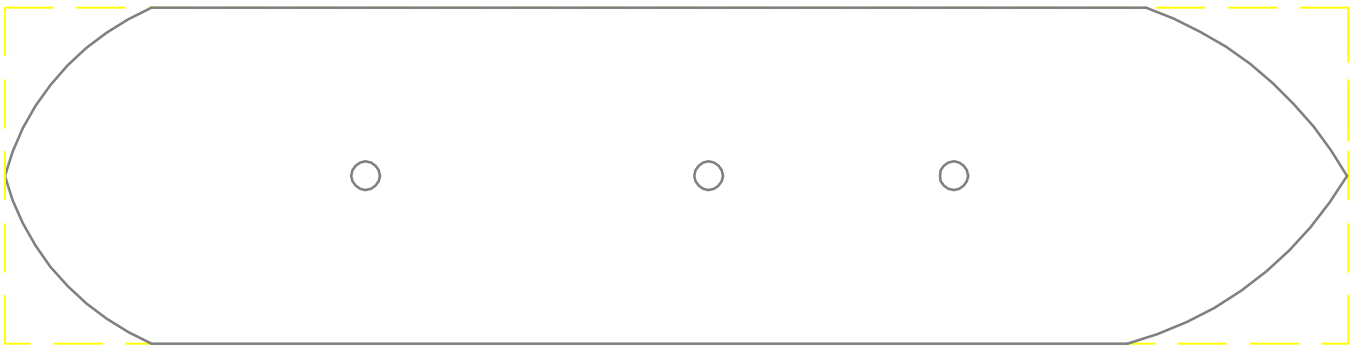

GLUE ON ROUNDED 1/2" DOWEL

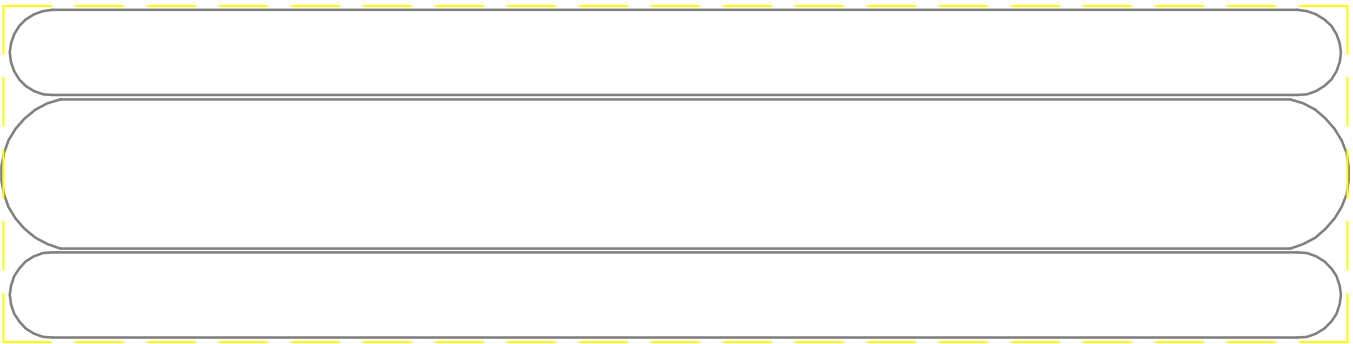
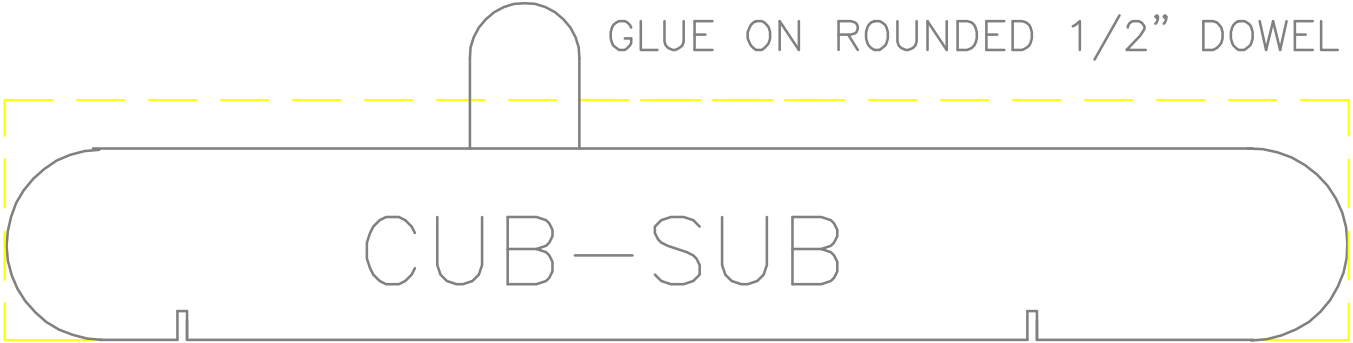

HOTDOGGER TOP VIEW

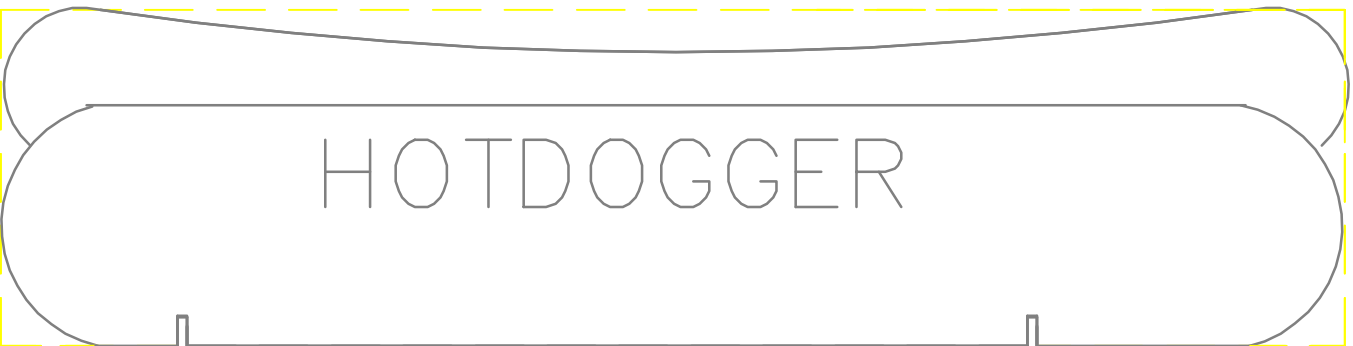

GLUE ADDITIONAL WOOD FOR HEIGHT

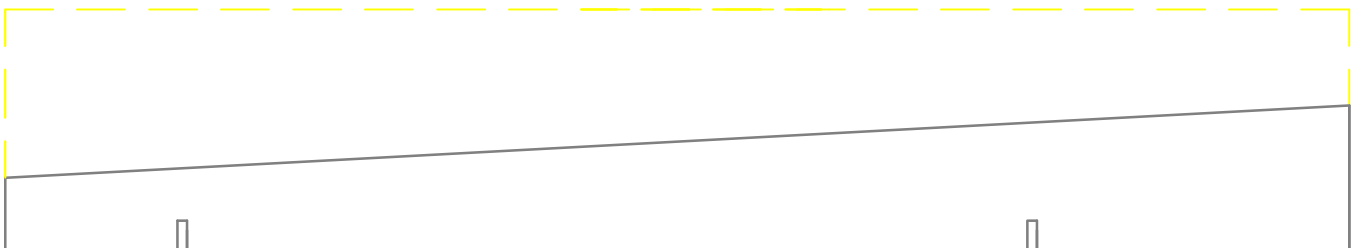

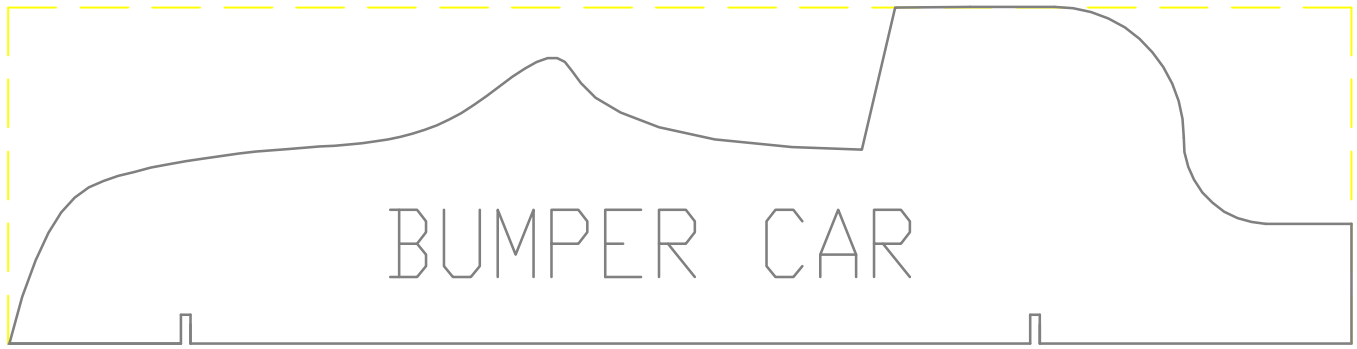

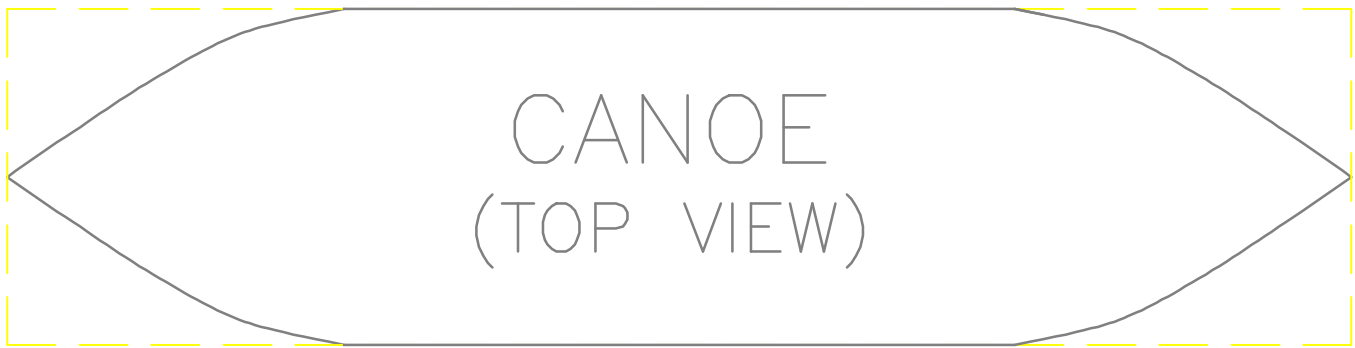
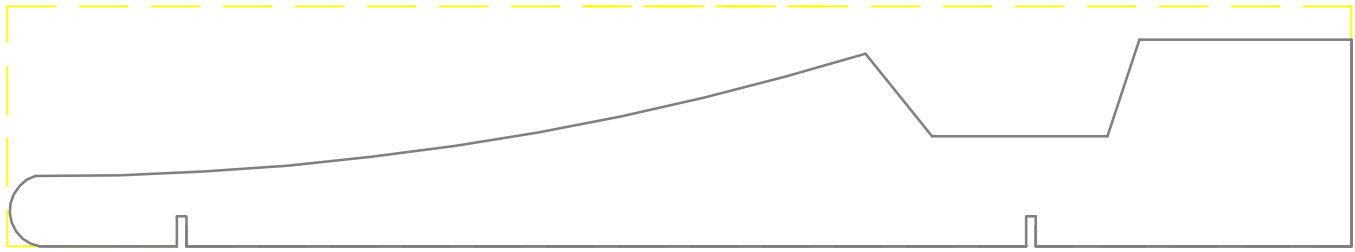
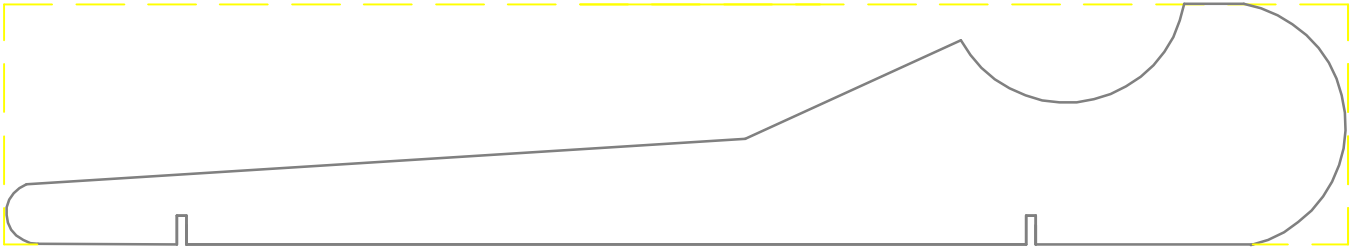

REQUIRES EXTRA HEIGHT

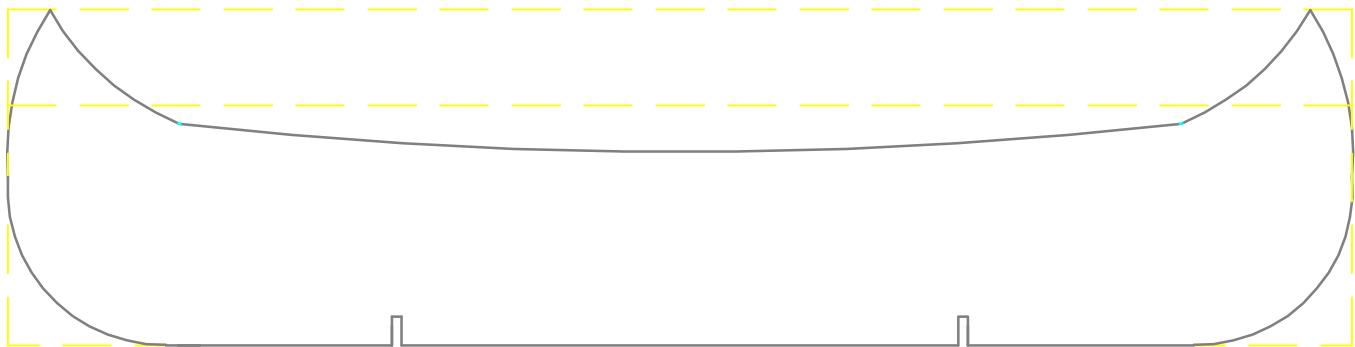

SHORTEN WHEELBASE

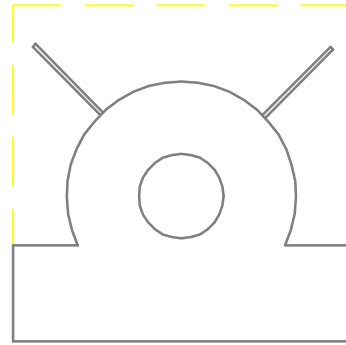
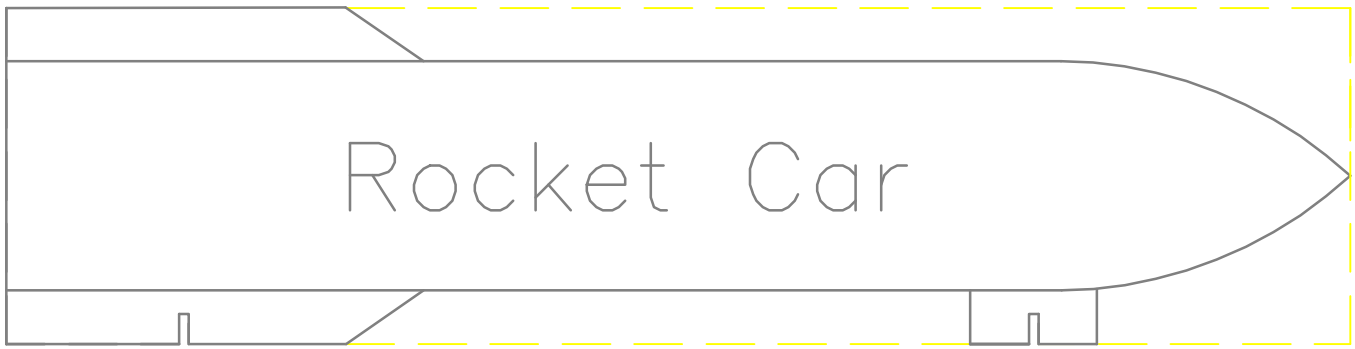

END VIEW

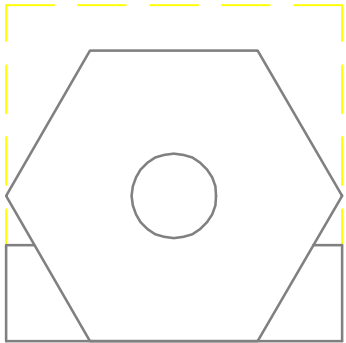

END VIEW

GLUE ADDITIONAL WOOD FOR THESE DESIGNS

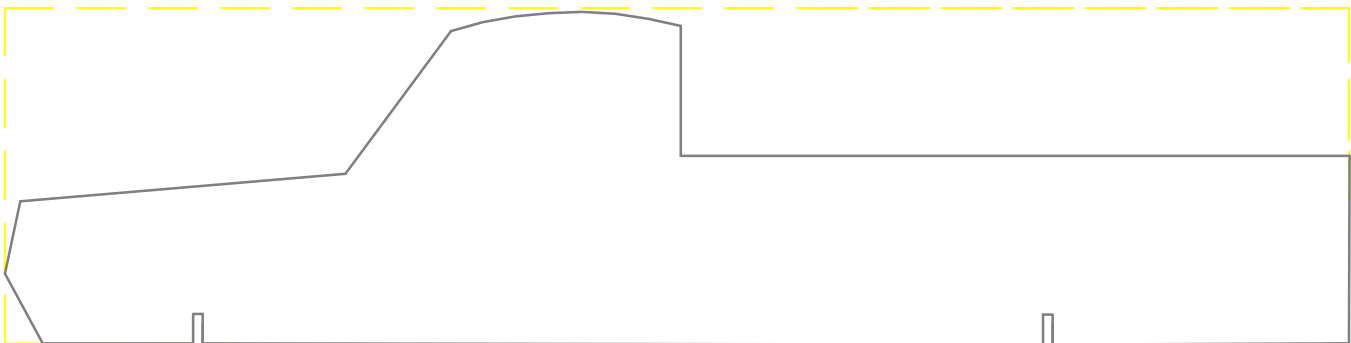
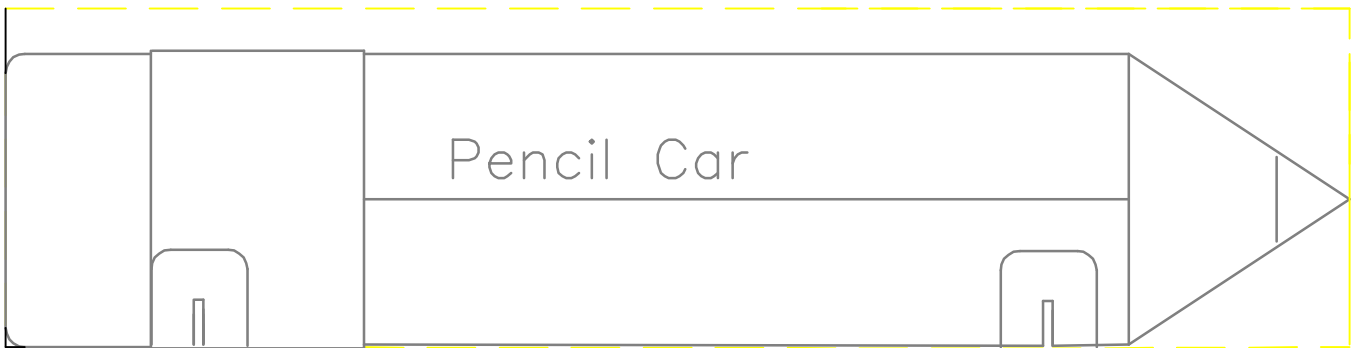

THE CRAYON CAR CAN BE CUT FROM THE STANDARD BLOCK THEN ROUTED TO REMOVE WOOD TO PROVIDE SPACE FOR ACTUAL CRAYONS TO BE INSERTED AS SHOWN. THE PAINT SCHEME COLORS DEPICT REALISTIC COLORS THAT MIGHT BE FOUND ON COMMERCIAL BOXES.

